

Room Alert®

Temperature & Environment Monitoring... *Made Easy!*



Room Alert® 32E, 12E, 4E & 3E

Phone **401.628.1600**
Fax **401.628.1601**
Web **AVTECH.com**

**User's Guide &
Reference Manual**

Copyright Information

© Copyright 1988-2021 AVTECH Software Inc.

All Rights Reserved. No part of this book may be used or reproduced for commercial benefit in any form or by any means, or stored in a database or retrieval system, without prior written permission of AVTECH Software Inc., except in the case of brief quotations embodied in articles and reviews. Making copies of any part of this book for any purpose other than your individual use is a violation of United States copyright laws and international treaty provisions. For information or additional copies, contact AVTECH Software Inc., as directed below. Published in the United States of America.

Warning and Disclaimer

This publication is shipped as is, without warranty of any kind, either express or implied. While every precaution has been taken in the preparation of this publication, the publisher and authors assume no responsibility for errors or omissions. Neither is any liability assumed for damages resulting from the use of the information or instructions contained herein. It is further stated that the publisher and authors are not responsible for any damage or loss to your data or equipment that may result directly or indirectly from your use of this publication and the related hardware & software. Nothing on any AVTECH website or in documentation shall be construed as conferring any license under any of the AVTECH Software (AVTECH) or any third party's intellectual property rights, whether by estoppel, implication, or otherwise.

Trademark Acknowledgements

AlertScript, AVTECH, the AVTECH Logo, AVTECH Software, the AVTECH System Manager Character, AVTECH.com, AVTECHSoftware.com, Environment Alarm, "Environment Monitoring Made Easy!", EnvironmentMonitor.com, "IT Environment Monitoring Made Easy!", MUPS, Device Discovery, Device ManageR, "Protect Your Facility... Don't Wait Until It's Too Late!", "Protect Your IT Environment... Don't Wait Until It's Too Late!", Room Alert, Room Alert Signal Tower, Signal Tower, RoomAlert.com, RoomAlert.co.uk, RoomAlert.eu, TemPageR, TemPageR.com and "Temperature Monitoring Made Easy!", WiSH, and WiSPR, are trademarks or registered trademarks of AVTECH Software Inc. Any other trademarks, product or company names mentioned herein are the property of their respective owners and used strictly for the purpose of identifying compatibility. AVTECH Software Inc. cannot attest to the accuracy of any other organization's ownership claim to a trademark and use of any trademark in this publication should not be regarded as affecting the validity of any trademark or service mark.

Contact Us

Worldwide Headquarters

AVTECH Software, Inc.
16 Cutler Street, Cutler Mill
Warren, RI 02885-2761 USA

Visit us on the web at [AVTECH.com](https://www.avtech.com)
Log in to your account at [RoomAlert.com](https://www.roomalert.com)

Sales

Need to expand your monitoring capacity? Visit our online store 24/7 at
https://www.avtech.com/Products/Environment_Monitors/

Want expert advice? Contact our Product Specialists Monday to Friday, 9 AM to 5 PM EST (excluding holidays).

Sales@AVTECH.com

Quote Request at <https://www.avtech.com/quote/>
Live Sales Chat at <https://www.avtech.com/>
888-220-6700 (In the USA & Canada, toll-free)
401-628-1600 (Outside the USA & Canada)

Technical Support

Questions about your product? Get answers 24/7 at our online Support Center.

Need more help? Contact our Technical Support Specialists Monday to Friday, 9 AM to 5 PM EST (excluding holidays).

Support@AVTECH.com

Live Support Chat at <https://www.avtech.com/support/>
888-220-6700 (In the USA & Canada, toll-free)
401-628-1600 (Outside the USA & Canada)

Table of Contents

Room Alert Hardware Options.....	2
Room Alert 3E	2
Room Alert 4E	2
Room Alert 12E.....	2
Room Alert 32E.....	3
Room Alert Hardware Features.....	4
Standard Room Alert Packages.....	5
How To Install Your Room Alert	6
Connect Your Room Alert Hardware	6
If Your Network Is Power Over Ethernet (PoE) Enabled (🟢 Room Alert 32E, 12E & 3E).....	6
If Your Network Is Not Power Over Ethernet (PoE) Enabled.....	6
Connect Included External Sensors And Other Compatible Components	6
How To Use Room Alert’s Web Interface	7
Status	7
Banner & Header	8
Sensor Display Area	9
Settings	12
Sensors.....	14
Alarms	21
Network	25
SMTP Email.....	28
Simple Network Management Protocol (SNMP).....	30
Security	33
Ping (🟢 Room Alert 4E).....	35
Advanced	36
Updating & Troubleshooting Your Room Alert.....	42
How To Download Firmware & Software Updates From RoomAlert.com	42
How To Update Room Alert’s Firmware	42
How To Discover Room Alert When Your Network Blocks UDP Broadcasts	42
How To Reset Room Alert To Factory Defaults	43

Room Alert Hardware Options

Room Alert 3E

Front

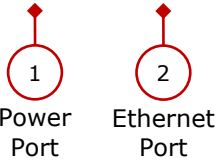
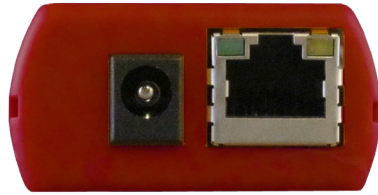

Back

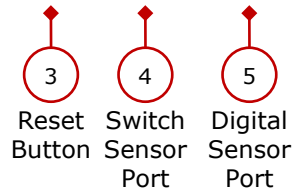

Internal Sensors
• Temperature

Room Alert 4E

Front

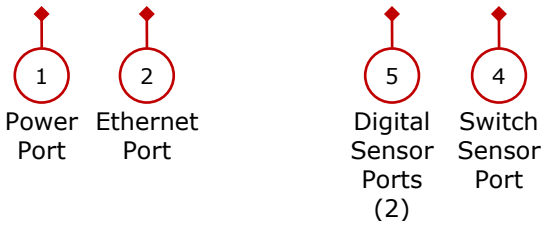

Back

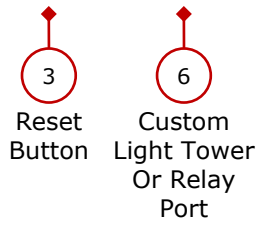
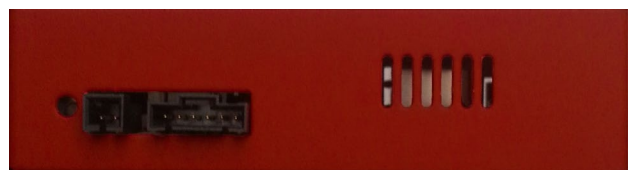

Internal Sensors
• Temperature

Room Alert 12E

Front

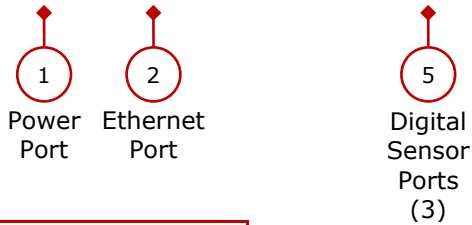
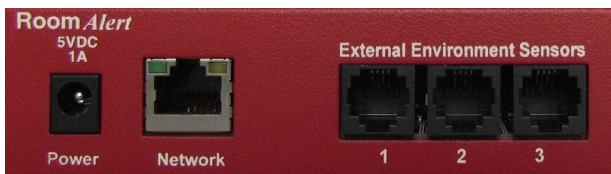

Internal Sensors
• Temperature

Back

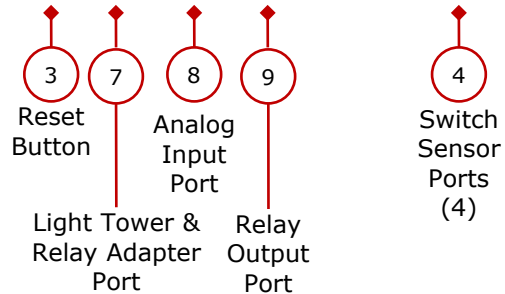
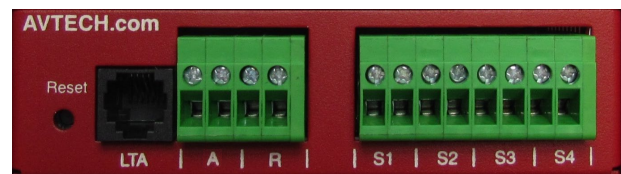

Room Alert 32E

Front

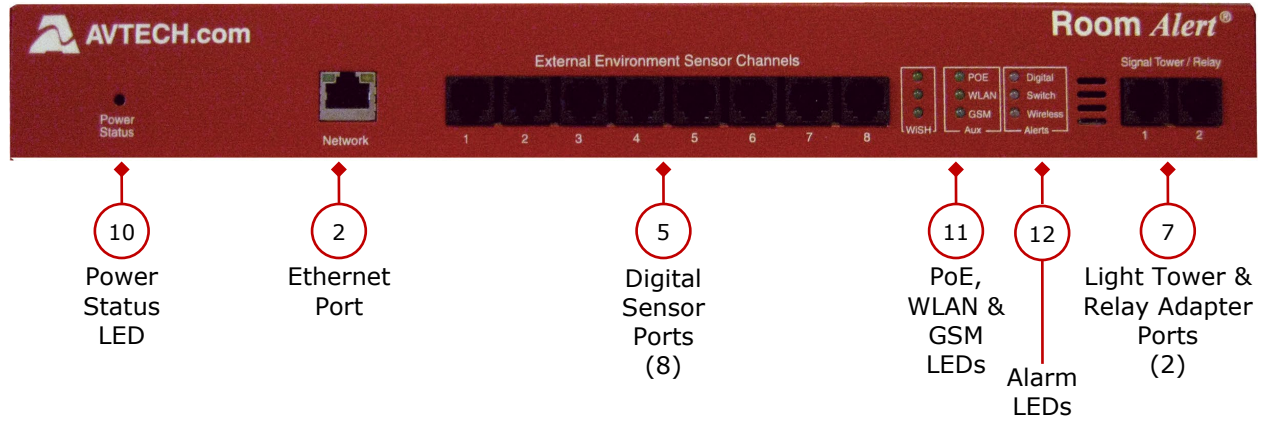



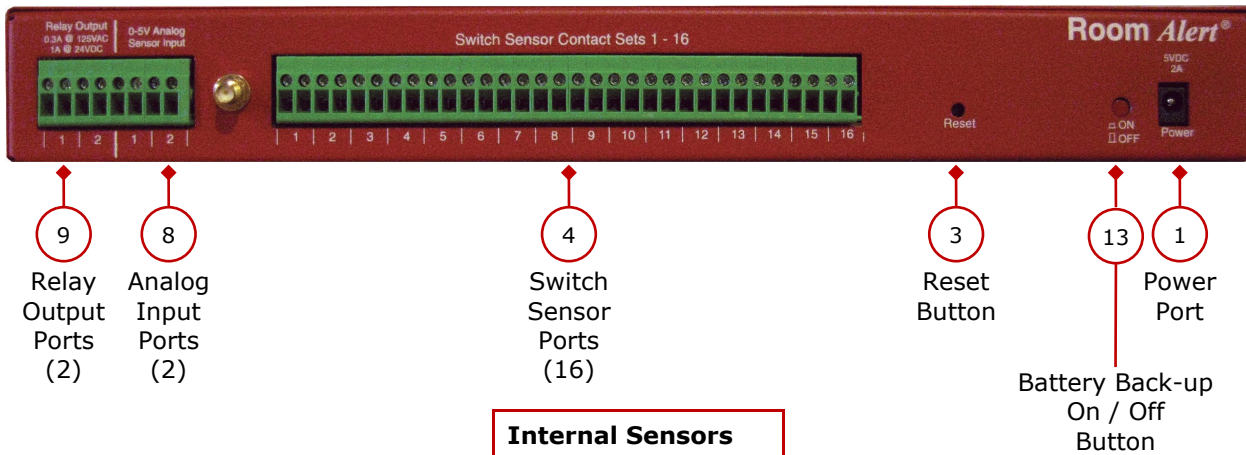



Back



Internal Sensors
• Temperature
• Humidity
• Power
• Battery Back-up

Room Alert Hardware Features

Internal Temperature Sensor	An internal digital sensor monitors ambient temperature with a range of -40° to 185° F (-40° to 85° C).
Internal Humidity Sensor  Room Alert 32E	An internal digital sensor monitors relative humidity with a range of 5% to 95% RH.
Internal Power Sensor  Room Alert 32E	An internal sensor monitors the power state (main power or battery-back up power).
Internal Battery Back-up  Room Alert 32E	An internal battery back-up can power Room Alert 32E for up to 15 minutes.
1 Power Port	A standard power port connects Room Alert to an electrical outlet with any AVTECH 5V 1A Power Adapter. Models are available for all countries.
2 Ethernet Port  PoE enabled on 32E, 12E & 3E	An RJ-45 port connects Room Alert to your network via an RJ-45 Ethernet cable.
3 Reset Button	A small push button resets Room Alert to factory default settings. (Please push softly.)
4 Switch Sensor Port(s)	Dry contacts connect Room Alert to any AVTECH switch sensor or dry contact on a device (e.g., HVAC, generator, pump, fan, etc.) via standard speaker wire or low-voltage 2-wire cable.
5 Digital Port(s)	Standard RJ-11 jack(s) connect any AVTECH digital sensor to Room Alert via a standard RJ-11 (straight through) telephone cord.
6 Custom Light Tower Or Relay Port  Room Alert 4E	The custom port allows you to directly connect a light tower or Relay Switch Sensor to Room Alert 4E.
7 Light Tower & Relay Adapter Port(s)  Room Alert 32E, 12E & 3E	A standard RJ-11 jack connects a Light Tower & Relay Adapter to Room Alert 32E, 12E or 3E via a standard RJ-11 (straight through) telephone cord.
8 Analog Input Port(s)  Room Alert 32E & 12E	Set(s) of contacts connect any low-voltage analog sensor to your Room Alert 32E or 12E via standard speaker wire.
9 Relay Output Port(s)  Room Alert 32E & 12E	Set(s) of contacts connect any low-voltage device to your Room Alert 32E or 12E via standard speaker wire.
10 Power Status LED  Room Alert 32E	An LED indicates the power status of Room Alert 32E: Green = Main or PoE, Red = Internal UPS power.
11 PoE, WLAN & GSM LEDs  Room Alert 32E	Three (3) LEDs indicate "in use" status of: <ul style="list-style-type: none">• Built-in PoE• WLAN (possible future use)• GSM (possible future use)

<p>12</p> <p>Alarm LEDs</p> <p> Room Alert 32E</p>	<p>LEDs light red or green to indicate alarm or clear status of Digital or Switch sensors: Green = Clear, Red = Alarm.</p>
<p>13</p> <p>On / Off Button</p> <p> Room Alert 32E</p>	<p>A push button turns the Room Alert 32E's internal battery back-up on and off.</p>

Standard Room Alert Packages

Room Alert 3E

The standard package includes:

- One (1) Room Alert 3E ID Box
- One (1) AVTECH 5V 1A Power Adapter
- One (1) Ethernet Cable (10')

Room Alert 4E

The standard package includes:

- One (1) Room Alert 4E ID Box (Rack Mount Bracket Optional)
- One (1) External Digital Temperature Sensor
- One (1) AVTECH 5V 1A Power Adapter
- One (1) Ethernet Cable (10')

Room Alert 12E

The standard package includes:

- One (1) Room Alert 12E ID Box
- One (1) External Digital Temperature & Humidity Sensor (25')
- One (1) AVTECH 5V 1A Power Adapter
- One (1) Ethernet Cable (10')

Room Alert 32E

The standard package includes:

- One (1) Room Alert 32E ID Box
- One (1) External Digital Temperature & Humidity Sensor (25')
- One (1) AVTECH 5V 1A Power Adapter
- One (1) Ethernet Cable (10')

How To Install Your Room Alert

Connect Your Room Alert Hardware

If Your Network Is Power Over Ethernet (PoE) Enabled (👉 Room Alert 32E, 12E & 3E)

- Connect one end of a standard Ethernet cable to the Room Alert's Ethernet port.
- Connect the other end to a PoE-enabled network jack.

That's it! Your Room Alert is now powered and discoverable on your network.



If Your Network Is Not Power Over Ethernet (PoE) Enabled

A. Connect To Your Network First

- Connect one end of a standard Ethernet cable to the Room Alert Ethernet port.
- Connect the other end to a network jack.

B. Then Connect To A Power Source

- Plug one end of AVTECH's 5V 1A Power Adapter into the Room Alert power port.
- Plug the other end into a surge-protected power source.

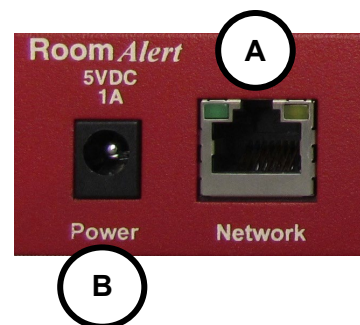

Your Room Alert is now powered and discoverable on your network!

NOTE

Use only AVTECH's 5V 1A Power Adapter. Other voltages could damage the Room Alert hardware and void your warranty. If you don't have an AVTECH 5V 1A Power Adapter, please visit our online store at [AVTECH.com](https://www.avtech.com) to acquire one. Models are available for all countries.

Connect Included External Sensors And Other Compatible Components

Please install included external sensors and any other compatible components you may have purchased according to their Installation Notes, available at [AVTECH.com](https://www.avtech.com).

How To Use Room Alert's Web Interface

You may configure your Room Alert through its built-in web interface. To access the interface, you may either:

- Type the IP address of your Room Alert monitor directly into the address bar of your web browser.
- Select your Room Alert monitor in the Device Discovery utility and click the **Web** button.
- Select your Room Alert monitor in the Room Alert Manager software and click the **Local IP** link.
- Select your Room Alert monitor in your RoomAlert.com account and click the **Device Interface** button.

Your Room Alert's web interface has 3 tabs:

- Status
- Settings
- Help

Status

To view your Room Alert's current sensor status, select **Status** in the navigation bar to the left of your screen.

The screenshot displays the Room Alert Monitor web interface. The top navigation bar is red with the 'Room Alert Monitor' logo and a menu icon. A left sidebar contains navigation options: Status (selected), Digital Sensors, Switch Sensors, Wireless Sensors, Light Towers and Relays, Analog Sensors, Settings, and Help. The main content area shows the device 'Example RA32E' with details: Type Room Alert 32E/W, MAC 1A:2B:3C:4D:5E:6F, Serial# RA32-123456, Firmware vX.X.X (checked), Local IP 192.168.2.131, and Power Status Main Power. A small image of the device is shown. An 'Account Status' box indicates the account is registered to AVTECH Example, with an Enterprise upgrade level and enabled push notifications. The last push was on 12/12/2017 at 12:19:30. Below this, the 'Sensors' section allows updates every 60 seconds and shows Fahrenheit as the selected unit. Under 'Digital Sensors', there are two sensor cards: 'Internal Sensor' (Temperature: 72.50 °F, Humidity: 23.19 %RH, Heat Index: 72.68 °F) and 'Ext Sensor 1' (Temperature: 72.60 °F).

Banner & Header

Banner

At the top of the page runs the red Room Alert banner.

Room Alert® Monitor



- You may collapse and expand the navigation bar on the left side of the page by selecting the menu icon in the banner.
- You may visit AVTECH.com by selecting the AVTECH logo in the banner.

Header

Below the banner is the header, where you may view basic information about your device.

Example RA32E 12/12/17 12:20:01

Type	Room Alert 32E/W		Account Status	
MAC	1A:2B:3C:4D:5E:6F		Registered To	AVTECH Example
Serial#	RA32-123456		Account Upgrade Level	Enterprise
Firmware	vX.X.X ✔		Push is	Enabled
Local IP	192.168.2.131		Connected	Last Push 12/12/2017
Power Status	Main Power			12:19:30

On the left side of the header, you may find the following information:

- Device Name
- Model
- MAC Address
- Serial Number
- Firmware Version
- Local IP Address
- Power Status ( Room Alert 32E)

On the right side of the header, you may find the following information under *Account Status*:

- The account your Room Alert monitor is registered to in RoomAlert.com.
- Your RoomAlert.com account level.

- Whether push to RoomAlert.com is enabled.
- Whether the Room Alert monitor is connected to your RoomAlert.com account.
- The time & date the Room Alert monitor last pushed sensor data to your RoomAlert.com account.

You may select **Account Status** to view the latest device information in your RoomAlert.com account.

Sensor Display Area

In the main viewing pane of the Status tab is the sensor display area. Here you may view your sensor data and temporarily change Status page settings.

The screenshot shows the 'Sensors' section of the interface. At the top, it says 'Sensors' and 'Updates Every 60 seconds'. There are radio buttons for 'Fahrenheit' (selected) and 'Celsius'. Below this is a section for 'Digital Sensors' with an upward arrow icon. It contains two sensor cards: 'Internal Sensor' and 'Ext Sensor 1'. The 'Internal Sensor' card shows 'Internal 1: Temperature / Humidity' and displays 'Temperature 71.96 °F' (with range 73.04 °F to 71.60 °F), 'Humidity 22.20 %RH' (with range 23.51 %RH to 21.88 %RH), 'Heat Index 71.96 °F' (with range 73.04 °F to 71.60 °F), and 'Dew Point Not Available'. The 'Ext Sensor 1' card shows 'External 1: Temperature' and displays 'Temperature 72.60 °F' (with range 75.75 °F to 69.22 °F).

Temporary Status Page Settings

You may temporarily change the refresh interval of the Status page and default temperature scale here.

This screenshot is similar to the previous one but highlights the settings for temporary changes. The 'Updates Every 60 seconds' field and the 'Fahrenheit' radio button are enclosed in red boxes, indicating they are the focus of the temporary settings.

- To temporarily modify the refresh interval of the Status screen, which is 60 seconds by default, you may enter a value in seconds in the *Update Every* field. Click outside the field to temporarily commit the change.
- To temporarily toggle the temperature scale between Fahrenheit (F) and Celsius (C),

select **Fahrenheit** or **Celsius**.

NOTE

Refer to the [Advanced](#) section in this manual for instructions on setting the default status page refresh rate and temperature scale for your Room Alert monitor.

Alarm Status Icons

Status icons are displayed for sensors that have thresholds set:

- ✔ Green circle with “✓” markSensor is in a clear state.
- ✘ Red circle with “X” markSensor is in an alarm state.
- No status iconSensor has no thresholds set.

High And Low Reading Icons

Arrows are displayed next to the highest and lowest readings on a sensor since the Room Alert last rebooted:

- ▲ Red upward arrowHighest reading since last reboot of your Room Alert.
- ▼ Blue downward arrow.....Lowest reading since last reboot of your Room Alert.

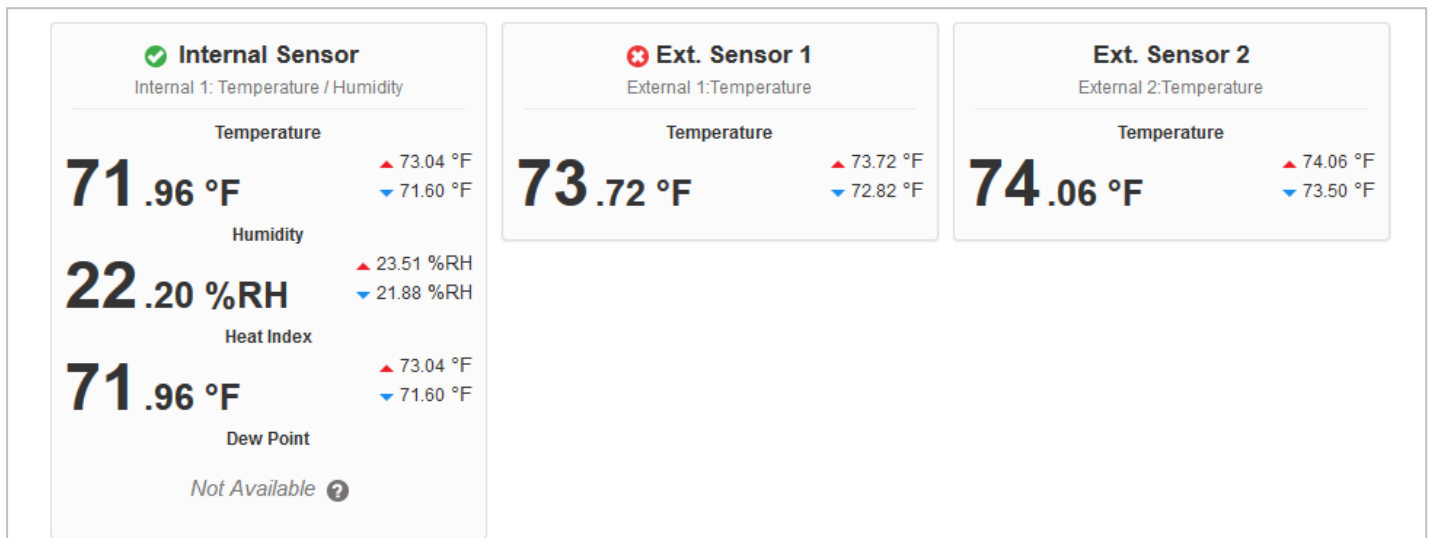

Navigating The Status Page

Your Room Alert displays your sensors in the following order:

- Digital Sensors
- Switch Sensors
- Light Towers and Relays
- Built-in Analog Sensors ([Room Alert 32E & 12E](#))

To navigate to the different types of sensors in the Sensor Display Area, you may scroll down the page or select the sensor category from the navigation bar to the left of your screen.

NOTE

Sensors connected to analog input ports and light tower & relay ports do not appear on the Status page until you enable them in the Settings screen. Refer to [Settings](#) in this manual for instructions.

Settings

Accessing Settings

To access your Room Alert's settings:

1. First select **Settings** in the navigation bar to the left of your screen.
2. Then select the **Click Here To Access Settings** button in the window that appears.

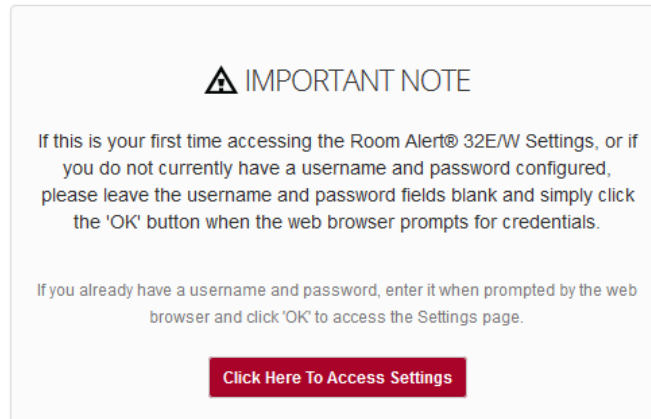

3. Your browser will prompt you for a username and password.
 - If you've set up a password for your Room Alert, enter it and select **OK**.
 - Otherwise, simply select **OK** without entering anything.

Navigating Settings

Settings has the following sub-tabs shown in the navigation bar to the left of your screen.

- Sensors
- Alarms
- Network
- SMTP
- SNMP
- Security
- Pings ( Room Alert 4E)
- Advanced

You may navigate to each of these sections by selecting the appropriate sub-tab. Settings opens by default to the *Sensor Settings* page.

Saving Settings

To save a setting, click out of the field you just modified and notice that a notification bar appears at the top and bottom of the page.



This notification bar contains the following items:

- A list of Settings pages you have unsaved changes on.
- A **Save Settings** button.
- A **Clear Changes** button.

You may navigate among the Settings pages, making changes in different places, and then save the changes all at once. When you are ready to save all the modifications you've made, select the **Save Settings** button. Your Room Alert will automatically reboot and commit your changes.

Before you save, if you decide you don't want the changes you just entered, you may re-load the page(s) without them by using the **Clear Changes** button. First select **Clear Changes**, and then select **OK** in the confirmation dialog box. Settings will re-load without your modifications. The Room Alert does not reboot, and any already-saved settings remain.

Sensors

Navigate to **Settings** → **Sensors** to open the Sensor Settings screen.

You may configure alert thresholds for your Room Alert's sensors in this screen. Your Room Alert sends alerts based on these thresholds.

NOTE

For more information about AVTECH sensors and accessories, please visit the [Sensors and Accessories](#) sections of AVTECH.com.

Room Alert[®] Monitor

Sensor Settings

General Alarm Configuration

Trigger Alarm If Sensor Is Disconnected?

Alarm Thresholds

Internal Sensor Alarm Configuration

Sensor Type: Temp/Humidity Use Alarm Profile: Profile 1

Sensor Label	Alarm On	High	Low	Adjust
Internal Sensor	Temperature (°F)	0	0	0
	Humidity (%R)	0	0	0

Monitor Heat Index

Sensor 1 Alarm Configuration

Sensor Type: Temperature Use Alarm Profile: Profile 1

Sensor Label	Alarm On	High	Low	Adjust
Ext Sensor 1	Temperature (°F)	0	0	0

NOTE

Notice the *Use Alarm Profile* drop-down menu next to each sensor. If you have an AVTECH Light Tower, Relay Switch Sensor or built-in relays on your Room Alert, you may configure Alarm Profiles to toggle them on and off when alarms are detected. Please refer to the [Alarms](#) section in this manual for further information.

General Alarm Configuration

General Alarm Configuration

Trigger Alarm If Sensor Is Disconnected?

Trigger Alarm If Sensor Is Disconnected?

You may configure your Room Alert to send an alert if any of the external digital sensors are disconnected from the unit.

1. Check **Trigger Alarm If Sensor Is Disconnected?** if you want to receive an alert if an external digital sensor becomes disconnected. This check box is blank by default.
2. Select **Save Settings** at the top or bottom of the page. Your Room Alert will automatically reboot and commit your changes.

Alarm Thresholds (Internal and External Digital Sensor Alarm Configuration)

You may configure alarm thresholds for the digital sensors—both internal and external—in this section.



Room Alert model 32E has an internal Temperature & Humidity Sensor.
Room Alert models 12E, 4E and 3E have an internal Temperature Sensor.

In the example below, we will configure a Digital Temperature Sensor:

Sensor Type: Temperature		Use Alarm Profile: Profile 1		
Sensor Label	Alarm On	High	Low	Adjust
Server Rm Temp	Temperature (°F)	78	60	0

1. In *Sensor Label*, you may leave the default label, “Internal Sensor” (or “Ext. Sensor 1,” etc.) or rename it to something more descriptive, such as “Server Rm Temp.”

TIP

Room Alert sensor labels may be up to 15 characters and can include the following: letters, numbers, spaces, hyphens (-), underscores (_) and periods (.).

2. The *Alarm On* field automatically fills in, in this case with “Temperature (F).”

NOTE

Refer to the [Advanced](#) section in this manual for instructions on setting the default temperature scale.

- In *High* and *Low*, you may leave the default, 0, or enter values for high and low temperature thresholds. Your Room Alert will generate alerts based on these thresholds.
- In *Adjust*, you may enter a value to adjust the temperature reading if it differs from a known value at that location.
- In *Use Alarm Profile*, which controls light towers and relays on your Room Alert, you may leave the default, **Profile 1**, or choose another profile from the drop-down menu

NOTE

If you have an AVTECH Light Tower, Relay Switch Sensor or built-in relays on your Room Alert, you may configure Alarm Profiles to toggle them on and off when alarms are detected. Please refer to the [Alarms](#) section in this manual for further information.

- Select **Save Settings** at the top or bottom of the page. Your Room Alert will automatically reboot and commit your changes.

TIP

The options in the *Sensor Alarm Configuration* fields vary slightly depending on the type of digital sensor.

Analog Sensor Settings (📡 Room Alert 32E & 12E)

If your Room Alert model has built-in analog input ports, you may configure the 0-5 VDC analog sensor connected to them in these fields.

In the example below, we are configuring AVTECH's Current Loop 1.

Analog Sensor Settings

Analog Sensor 1 Alarm Configuration

Sensor Label	High	Low	Adjust	Enabled	Enable <input checked="" type="checkbox"/>	High	Low
Current Loop 1	6	2	0	<input checked="" type="checkbox"/>	Reference	5	0
Use Alarm Profile: Profile 1					Scale	10	0
					Units	Amp	

- First, enable the sensor by selecting **Enabled** in the set of fields on the left of the screen. The built-in analog sensor will not appear in the Room Alert web interface, Room Alert Manager, your [RoomAlert.com](#) account or SNMP program unless it is enabled.
- In the set of fields on the right of the screen, select **Enable** to turn on the *Reference*, *Scale* and *Units* fields.

- In *Reference*, enter values from 5 to 0 that represent the *High* and *Low* points of your analog sensor's output signal range. In the case of the Current Loop 1, which outputs a signal of 0-5 VDC, we've left the default values.
- In *Scale*, enter the *High* and *Low* points of the scale you want the *Reference* reading to be converted to. In our Current Loop example, we would like to convert 0-5 volts to 0-10 amps, so we've replaced the default of 5 in *High* with 10 and left the default of 0 in *Low*.
- In *Units*, enter a 1 to 3-character label for the unit type that your readings will be measured in. If you are measuring amperage, as with the Current Loop, you might enter "A" or "Amp," for example. Note that this field is merely a label and does not affect any of the calculations.

3. Return to the left side of the screen to enter your sensor label and thresholds:

- In *Sensor Label*, you may leave the default, "Analog Sensor 1" or choose something more descriptive, such as "Current Loop 1" or "Cryogenic Temp."

TIP

Room Alert sensor labels may be up to 15 characters and can include the following: letters, numbers, spaces, hyphens (-), underscores (_) and periods (.).

- In *High* and *Low*, you may leave the default, 0—which means no alarm is configured—or enter values that fall within the *Scale* range from the previous step. In our example, we entered a conversion scale of 0 to 10 (amps) in the previous step for the Current Loop, and we've chosen to generate alarms at the high and low thresholds of 6 and 2 (amps).

TIP

With the custom scale enabled, you may enter positive and negative whole numbers in *High* and *Low* that fall within the *Scale* range; with the custom scale disabled, you may enter decimal numbers in the range of +/-5.0 (for 0-5 VDC).

- In *Adjust*, you may enter a value to adjust the reading if it differs from a known value.

TIP

With the custom scale enabled, you may enter decimal numbers in *Adjust* in the range of +/-12.0; with the custom scale disabled, you may enter decimal numbers in the range of +/-5.0.

4. In *Use Alarm Profile*, which controls light towers and relays on your Room Alert, you may leave the default, **Profile 1**, or choose another Alarm Profile from the drop-down menu.

NOTE

If you have an AVTECH Light Tower, Relay Switch Sensor or built-in relays on your Room Alert, you may configure Alarm Profiles to toggle them on and off when alarms are detected. Please refer to the [Alarms](#) section in this manual for further information.

5. Select **Save Settings** at the top or bottom of the page. Your Room Alert will automatically reboot and commit your changes.

External Switch Sensor Settings

You may configure the alert state for the external switch sensors in the *Switch Sensor Settings* fields. Shown below are the default settings.

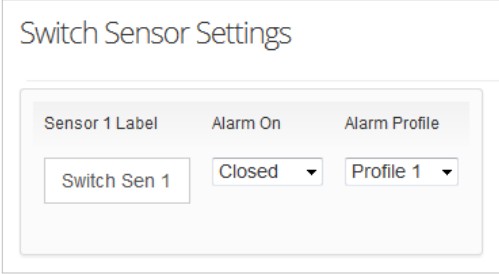

The screenshot shows a web interface titled "Switch Sensor Settings". It contains three columns: "Sensor 1 Label", "Alarm On", and "Alarm Profile". Under "Sensor 1 Label" is a text input field containing "Switch Sen 1". Under "Alarm On" is a dropdown menu with "Closed" selected. Under "Alarm Profile" is a dropdown menu with "Profile 1" selected.

Your Room Alert monitors your switch sensors for an "Open" or "Closed" circuit state. Room Alert defaults to alarming on "Closed," as you can see above; you may, however, need to change that depending on your sensor. AVTECH's Motion Sensor, for example, is "Open" when it detects movement and "Closed" when it doesn't; in that case, you'd likely want to configure the sensor to alarm on "Open" or when motion is detected.

The Alarm And Clear State Of Your Switch Sensor

To determine the alarm and clear state of your sensor, you may either refer to its Installation Note or see for yourself by physically connecting your sensor to your Room Alert and then observing what happens to its circuit state in the Status page.

After you connect your sensor and before you configure it in the Settings page, follow these steps:

1. Select the **Status** tab in the navigation bar to the left of your screen.
2. Scroll down to the Switch Sensors and look at the circuit state of the channel you connected your sensor to. If you connected your sensor to the first switch sensor port on Room Alert, look at Channel 1; if you connected it to the second, look at Channel 2, etc.

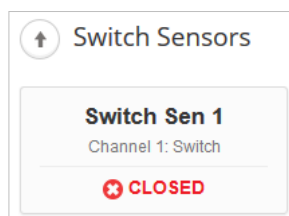

3. Notice the circuit state of Switch 1. It should show the normal state, which in this case is

“Closed.” (Ignore the red color coding for now. We haven’t configured the sensor yet, so it’s still set at the default: alarm on closed.)

4. Now put the sensor into an alarm state. To put a Motion Sensor into an alarm state, for example, wave your hand in front of it.
5. Look at the circuit state at the same time. You should see it switch to the opposite of normal. In this example, if normal is “Closed,” you see the alarm state as “Open.” (Again, ignore the green color coding for now.)

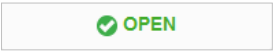

Now that you’ve checked what “Open” and “Closed” mean on your switch sensor, navigate to **Settings** → **Sensors** to configure your options in *Switch Sensor Settings*:

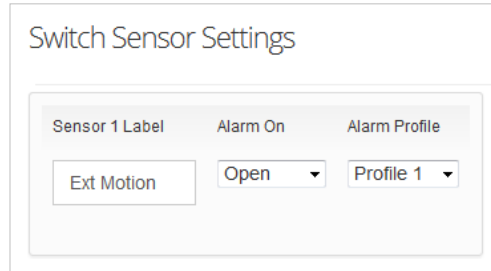

1. In *Sensor Label*, you may leave the default, “Switch 1” (2, 3 or 4) or enter something more descriptive, such as “Ext Motion” or “Main Entry.”

TIP

Room Alert sensor labels may be up to 15 characters and can include the following: letters, numbers, spaces, hyphens (-), underscores (_) and periods (.).

2. In *Alarm On*, select the alarm state (**Open** or **Closed**). In our example, the alarm state is **Open**.
3. In *Alarm Profile*, which controls light towers and relays on your Room Alert, you may leave the default, **Profile 1**, or choose another Alarm Profile from the drop-down menu.

NOTE

If you have an AVTECH Light Tower, Relay Switch Sensor or built-in relays on your Room Alert, you may configure Alarm Profiles to toggle them on and off when alarms are detected. Please refer to the [Alarms](#) section in this manual for further information.

4. Select **Save Settings** at the top or bottom of the page. Your Room Alert will automatically reboot and commit your changes.

TIP

For any of the switch sensor sets you leave unused on your Room Alert, choose **Disabled** from the *Alarm On* drop-down menu to avoid confusion or false alerts.

Internal Power Sensor Alarm Configuration (📶 Room Alert 32E)

You may configure the power sensor that is built in to the Room Alert 32E here. This internal power sensor triggers on loss of main power and can send a notification while the battery back-up keeps the Room Alert monitor powered for a short time.

Internal Power Sensor Alarm Configuration

Sensor Type: Power

Sensor Label	Alarm On	Use Alarm Profile:
Power Sensor	Alarm On Power Loss <input checked="" type="checkbox"/>	Profile 1 ▼

1. In *Sensor Label*, you may leave the default “Power Sensor” or enter something more descriptive, such as “RA32 Power.”

TIP

Room Alert sensor labels may be up to 15 characters and can include the following: letters, numbers, spaces, hyphens (-), underscores (_) and periods (.).

2. In *Alarm On Power Loss*, you may leave the checkbox filled in if you wish to receive an alert when your Room Alert 32E loses its main power source. Otherwise, you may uncheck it.
3. In *Alarm Profile*, which controls light towers and relays on your Room Alert, you may leave the default, **Profile 1**, or choose another Alarm Profile from the drop-down menu.

NOTE

If you have an AVTECH Light Tower, Relay Switch Sensor or built-in relays on your Room Alert, you may configure Alarm Profiles to toggle them on and off when alarms are detected. Please refer to the [Alarms](#) section in this manual for further information.

4. Select **Save Settings** at the top or bottom of the page. Your Room Alert will automatically reboot and commit your changes.

Alarms

Navigate to **Settings** → **Alarms** to open the *Alarm Settings* screen. Here you may configure light towers and relays.

Room Alert

Alarm Settings

LTA 1 Label: Light Tower 1
LTA 1 Connected: No Light Tower/Relay Connected
Relay 1 Label: Relay Output 1

LTA 2 Label: Light Tower 2
LTA 2 Connected: No Light Tower/Relay Connected
Relay 2 Label: Relay Output 2

Profile 1 Choose an Alarm or Boot Profile to view or edit.

Relay 1 Action Configuration

Profile 1	Relay
On Alarm	None
On Clear	None

Relay 2 Action Configuration

Profile 1	Relay
On Alarm	None
On Clear	None

Light Tower/Relay Profile Configuration

In this example, we'll select and name a Light Tower w/Audio in *LTA 1* and then configure its Profile 1.

Alarm Settings

LTA 1 Label: Server Rm RYG
LTA 1 Connected: Red/Yellow/Green w/ Audio
Relay 1 Label: Relay Output 1

Profile 1 Choose an Alarm or Boot Profile to view or edit.

LTA 1 Action Configuration

Profile 1	Red LED	Orange LED	Green LED	Audio 1	Audio 2	LTA Relay
On Alarm	On	Off	Off	Off	Off	On
On Clear	Off	Off	On	Off	Off	Off

1. In *LTA 1 Label*, you may leave the default, "Light Tower 1" or enter something more descriptive, such as "Server Rm RYG."

- In *LTA 1 Connected*, select the appropriate option from the choices in the drop-down menu. For this example, we are choosing **Red/Yellow/Green w/Audio** for the Light Tower w/Audio.
- Once you choose your device, the Alarm Profile configuration grid beneath it expands. Notice that all features are set to **Off** by default.

TIP

The features available vary depending on the device you've selected.

- Choose the Profile you wish to configure in the Profile drop-down list. Depending on your model, you may have 1 to 5 available Profiles, plus a Boot Profile where you can configure what the light tower or relay features do when the device first boots.



- All models have the Boot Profile.
- Room Alert model 32E offers 5 additional profiles (Profiles 1 - 5).
- Room Alert model 12E offers 3 additional profiles (Profile 1 - 3).
- Room Alert models 4E and 3E offer 1 additional profile (Profile 1).

Light Tower & Relay Adapter (LTA)

A Light Tower & Relay Adapter gives you the option to add an AVTECH Light Tower, Light Tower w/Audio or Relay Switch Sensor to a **Room Alert 32E, 12E or 3E**. (The **Room Alert 4E** does not require a Light Tower & Relay Adapter, allowing for a direct connection.)

You may also connect a low-voltage device directly to the built-in relay port on the Light Tower & Relay Adapter.

Shown here is a sample configuration:



**Room Alert
32E, 12E or 3E**



**RJ-11
Cable**



**Light Tower
& Relay Adapter**



**Light Tower
Custom Cord**

**Light Tower
w/Audio**

NOTE

The Light Tower w/Audio in this configuration can be replaced with a standard Light Tower or Relay Switch Sensor. For more information about AVTECH sensors and accessories, please visit the Sensors & Accessories sections of AVTECH.com.

Relay Action Configuration (📶 Room Alert 32E & 12E)

Here you may set the devices connected through the built-in relay output port(s) to turn on or off in response to your Room Alert 32E or 12E rebooting or its sensors going in and out of alarm state.

In this example, we'll configure Relay 1.

Profile 1	Relay
On Alarm	On
On Clear	Off

1. In *Sensor Label*, you may leave the default, "Relay Output 1," or enter something more descriptive, such as "Server Rm AC."

TIP

Room Alert sensor labels may be up to 15 characters and can include the following: letters, numbers, spaces, hyphens (-), underscores (_) and periods (.).

2. Choose the Profile you wish to configure in the Profile drop-down list. Depending on your model, you may have 3 to 5 available Profiles, plus a "Boot" profile where you can configure what the built-in Relay does when the Room Alert monitor boots on.



- Room Alert model 32E offers the "Boot" profile plus 5 additional profiles.
- Room Alert model 12E offers the "Boot" profile plus 3 additional profiles.

Working with a Room Alert 12E purchased in 2021? Please see our FAQ, [Why Your Room Alert 12E Built-in Relay Behavior May Be Reversed](#).

Associate Alarm Profiles With Sensors

Each sensor is set at Profile 1 by default; connected light towers, built-in LTA relays, Relay Switch Sensors and built-in relay outputs execute Profile 1 when that sensor goes into an alarm state.

You may associate a profile with a sensor by following the steps below. In this example from a Room Alert 32E, you can see we have 5 profiles to choose from:

1. Navigate to **Settings** → **Sensors**.
2. Find your sensor's interface and choose the profile you've configured from the drop-down list in *Use Alarm Profile*. Note that the default for all sensors is **Profile 1**. You may also choose **No Alarm** if you do not want to associate your sensor with a profile.

Sensor Label	Alarm On	High	Low
Server Rm Temp	Temperature (°F)	78	60

3. Select **Save Settings** at the top or bottom of the page. Your Room Alert will automatically reboot and commit your changes.

TIP

Alarm Profiles affect only light towers and relays; they do not affect email alerts.

Network

Navigate to **Settings** → **Network** to open the *Network Settings* screen.

Device Name

To rename your Room Alert:

1. Select the automatically-assigned name in *Device Name* and enter a new one of up to 15 alphanumeric characters.

TIP

Room Alert device names may be up to 15 characters and can include the following: letters, numbers, spaces, hyphens (-), underscores (_) and periods (.).

2. Select **Save Settings** at the top or bottom of the page. Your Room Alert will automatically reboot and commit your changes.

IP Address Configuration—DHCP

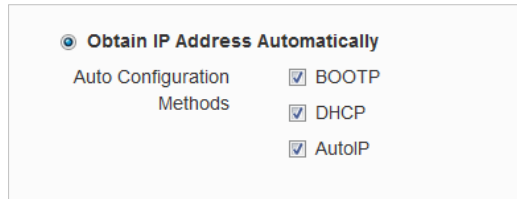

The screenshot shows a configuration panel for DHCP. At the top, the radio button 'Obtain IP Address Automatically' is selected. Below it, the text 'Auto Configuration Methods' is followed by three checked checkboxes: 'BOOTP', 'DHCP', and 'AutoIP'.

To obtain an IP address automatically using DHCP:

1. Select **Obtain IP Address Automatically**.
2. Typically, leave the *BOOTP*, *DHCP* and *AutoIP* checked (enabled), which is the default.
3. Select **Save Settings** at the top or bottom of the page. Your Room Alert will automatically reboot and commit your changes.

IP Address Configuration—Static IP

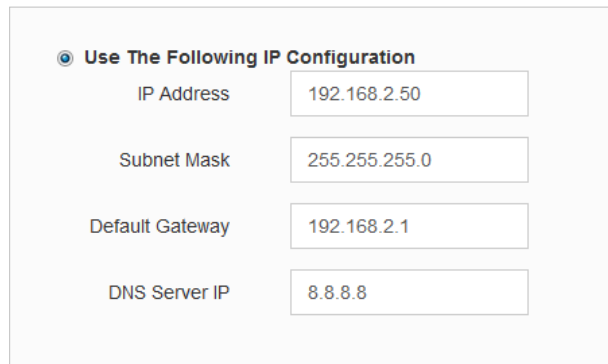

The screenshot shows a configuration panel for static IP. The radio button 'Use The Following IP Configuration' is selected. Below it are four input fields with the following values: 'IP Address' (192.168.2.50), 'Subnet Mask' (255.255.255.0), 'Default Gateway' (192.168.2.1), and 'DNS Server IP' (8.8.8.8).

To assign a static IP address:

1. Select **Use The Following IP Configuration**.
2. In *IP Address*, enter the new static IP address.
3. In *Subnet Mask*, enter the subnet mask.
4. In *Default Gateway*, enter the gateway IP address.
5. In *DNS Server IP*, enter the DNS server IP address.
6. Select **Save Settings** at the top or bottom of the page. Your Room Alert will automatically reboot and commit your changes.

TIP

Make sure that you do not use an IP address that is already assigned to another device. Also, set the IP address within your current subnet range; otherwise, you may not be able to discover your Room Alert.

Ethernet Configuration

Typically, you may leave the *Ethernet Configuration* section at the defaults, which are shown below.

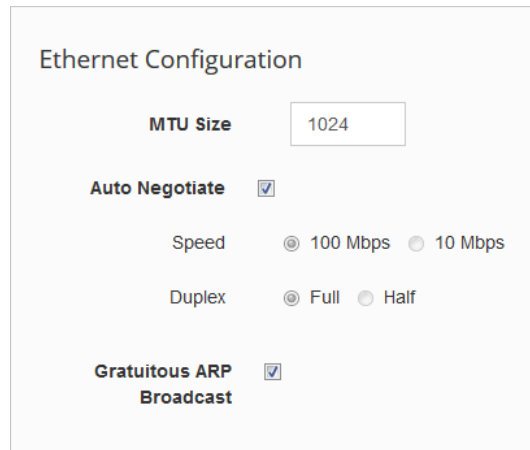

Ethernet Configuration

MTU Size

Auto Negotiate

Speed 100 Mbps 10 Mbps

Duplex Full Half

Gratuitous ARP Broadcast

However, if you connect your Room Alert to a managed switch that controls your network traffic, you may need to change these settings:

1. In *MTU Size*, you may leave the default, 1024, or enter a value as low as 512.
2. You may uncheck **Auto Negotiate** and choose:
 - For *Speed*, **100 Mbps** or **10 Mbps**.
 - For *Duplex*, **Full** or **Half**.
3. You may uncheck **Gratuitous ARP Broadcasts** to disable them.
4. Select **Save Settings** at the top or bottom of the page. Your Room Alert will automatically reboot and commit your changes.

SMTP Email

You may configure your Room Alert to send alerts via email and email-to-SMS.

Navigate to **Settings** → **SMTP Email** to open the *Email Settings* screen.

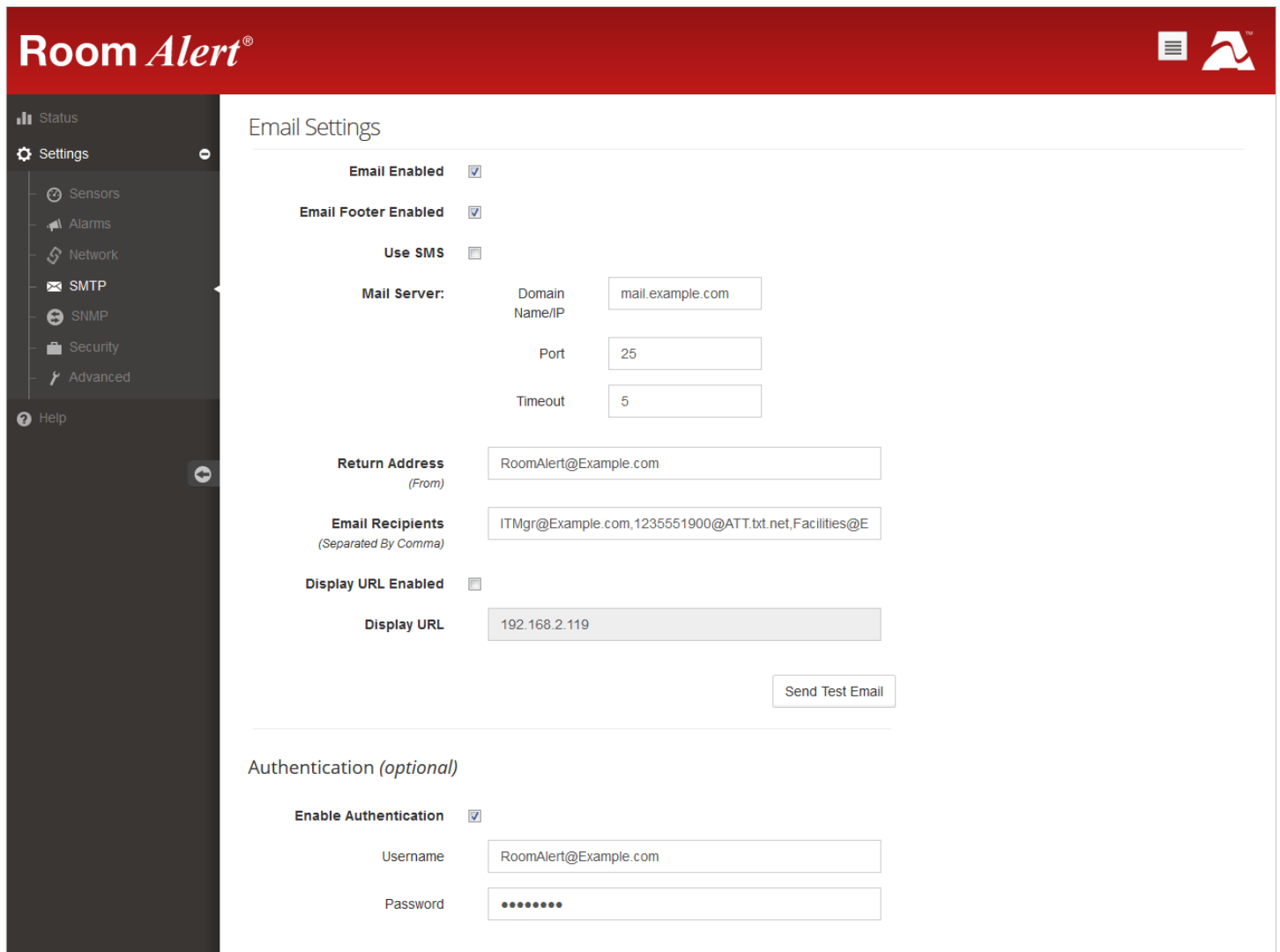

Room Alert®

Status

Settings

- Sensors
- Alarms
- Network
- SMTP
- SNMP
- Security
- Advanced

Help

Email Settings

Email Enabled

Email Footer Enabled

Use SMS

Mail Server:

Domain Name/IP:

Port:

Timeout:

Return Address (From):

Email Recipients (Separated By Comma):

Display URL Enabled

Display URL:

Authentication (optional)

Enable Authentication

Username:

Password:

1. Check **Email Enabled**.
2. You may leave **Email Footer Enabled** checked to include AVTECH contact information with email messages.
3. You may check **Use SMS** to send a shorter email with a reduced character count.
4. *Mail Server:*
 - In *Domain Name/IP*, enter the domain name or IP address of your mail server.
 - In *Port*, enter your mail server's SMTP port. The default is 25, a commonly-used port.
 - In *Timeout*, you may leave the default, 5 seconds, or enter another interval.

5. In *Return Address (From)*, enter an email address that resides on your mail server. This is the address alert messages will come from.
6. In *Email Recipients*, enter the email and email-to-SMS addresses that you'd like to send alerts to. Separate each address with a comma. (Do not enter spaces after the commas.)
 - Email address: ITMgr@Example.com
 - Email-to-SMS address: 1235551900@ATT.txt.net
 - Addresses separated by commas: ITMgr@Example.com,1235551900@ATT.txt.net, etc.
7. *Display URL* controls what IP or URL displays in email alerts. You may leave the default, a disabled, blank field, or enter a custom IP address or URL. To make a custom entry, you must first check **Display URL Enabled**.
 - When this field is left at the default (disabled, blank), your email alerts will contain the Room Alert's current IP address and HTTP port number in the body of the email.
 - When this field is overwritten with a custom IP or URL, your email alerts will contain that custom IP or URL in the body of the email.

Authentication (Optional)

8. If your mail server requires SMTP authentication, check **Enable Authentication**.
9. In *Username* and *Password*, enter a valid username and password for your mail server that will facilitate authentication.

TIP

Your password cannot be more than 11 alphanumeric characters.

10. Select **Save Settings** at the top or bottom of the page. Your Room Alert will automatically reboot and commit your changes.

When your Room Alert reboots, return to the *Email Settings* screen and select **Send Test Email** to send a test email to the addresses you entered in *Email Recipients*.

Simple Network Management Protocol (SNMP)

Because your Room Alert is fully SNMP-compliant, you have the option to monitor it with a 3rd-party monitoring application capable of performing SNMP queries. You may configure Room Alert to send SNMP Traps in response to a change in alarm states to up to three host systems running 3rd-party SNMP monitoring applications.

If you use a 3rd-party SNMP monitoring application:

- Obtain the Room Alert MIB files and load them into your SNMP monitoring application. Otherwise, your application cannot properly translate the data it receives in the SNMP Trap.

NOTE

You may download the MIB files from the *SNMP Settings* page in your Room Alert's web interface.

- Ensure that your application uses SNMPv1.
- Note that your Room Alert communicates with your SNMP monitoring application using the standard port for the SNMP protocol, 161.

Navigate to **Settings** → **SNMP** to open the *SNMP Settings* screen.

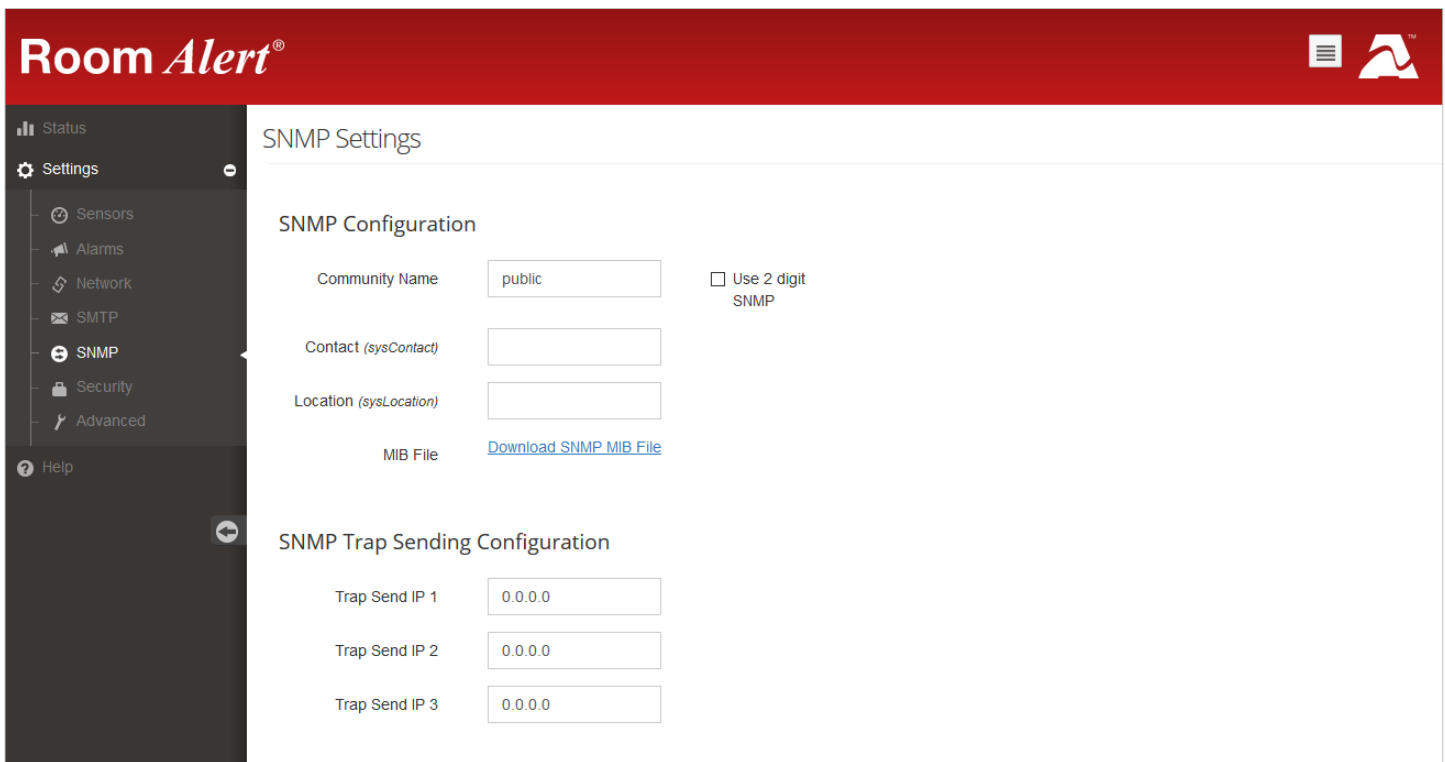

The screenshot displays the 'Room Alert' web interface. The top navigation bar is red with the 'Room Alert' logo on the left and a menu icon on the right. A dark sidebar on the left contains a navigation menu with options: Status, Settings (selected), Sensors, Alarms, Network, SMTP, SNMP, Security, and Advanced. Below the menu is a 'Help' button. The main content area is titled 'SNMP Settings' and is divided into two sections:

- SNMP Configuration:** This section contains a 'Community Name' field with the value 'public', a checkbox for 'Use 2 digit SNMP' which is unchecked, a 'Contact (sysContact)' field, a 'Location (sysLocation)' field, and a 'MIB File' section with a blue link labeled 'Download SNMP MIB File'.
- SNMP Trap Sending Configuration:** This section contains three 'Trap Send IP' fields, each with the value '0.0.0.0'.

SNMP Configuration

To begin configuring your Room Alert for SNMP:

SNMP Configuration

Community Name: public Use 2 digit SNMP

Contact (sysContact): IT Manager

Location (sysLocation): Data Center

1. In *Community Name*, you may leave the default SNMP protocol community name, “public,” or enter a new name.

TIP

The community name you assign here must match the one in your 3rd-party SNMP monitoring application.

2. You may leave *Contact (sysContact)* blank or enter a person’s name to specify who is receiving the information.
3. You may leave *Location (sysLocation)* blank or enter the location of your Room Alert monitor.
4. You may select **Use 2 digit SNMP** if you prefer to receive values in 2-digit rather than 4-digit format.

TIP

Room Alert sends values to your 3rd-party SNMP monitoring application in 4-digit format by default. 78.55° F, for example, appears as 7855. In 2-digit format, your values are truncated, not rounded to the nearest number. In this example, 78.55 would appear as 78.

5. Select **Save Settings** at the top or bottom of the page. Your Room Alert will automatically reboot and commit your changes.

SNMP Trap Sending Configuration

You may configure your Room Alert to send SNMP Traps in response to a change in alarm state to up to three host systems running 3rd-party SNMP monitoring applications. Each host system you enter in these fields will receive the same SNMP Traps simultaneously.

SNMP Trap Sending Configuration

Trap Send IP 1	192.168.2.100
Trap Send IP 2	192.168.2.101
Trap Send IP 3	0.0.0.0

To configure your Room Alert to send SNMP Traps:

1. In *Trap Send IP 1*, enter the IP address of the host system that runs your 3rd-party SNMP monitoring application.
2. In *Trap Send IP 2* and *Trap Send IP 3*, you may enter the IP addresses of other host systems that run 3rd-party SNMP monitoring applications, or leave the default, 0.0.0.0.
3. Select **Save Settings** at the top or bottom of the page. Your Room Alert will automatically reboot and commit your changes.

SNMP Trap Receiving Configuration (🔗 Room Alert 4E)

You may configure your Room Alert 4E to receive SNMP Traps from up to three other network devices, such as printers, fax machines, etc. When Room Alert 4E receives a trap message, it generates an alarm and can send an email.

SNMP Trap Receiving Configuration

Enable Trap Receive Alerts

Trap Receive IP 1	192.168.2.200
Trap Receive IP 2	192.168.2.201
Trap Receive IP 3	0.0.0.0

To configure your Room Alert 4E to receive SNMP Traps:

1. Leave the *Enable Trap Receive Alerts* checkbox filled in, which is the default.
2. In *Trap Receive IP 1*, enter the IP address of the network device.
3. In *Trap Receive IP 2* and *Trap Receive IP 3*, you may enter the IP addresses of other network devices, or leave the default, 0.0.0.0.
4. Select **Save Settings** at the top or bottom of the page. Your Room Alert will automatically reboot and commit your changes.

If all of the *Trap Receive IP* addresses are left blank, any SNMP trap received will generate an alarm.

Security

By default, Room Alert does not require log in credentials; you may, however, create a password for your Room Alert for extra security.

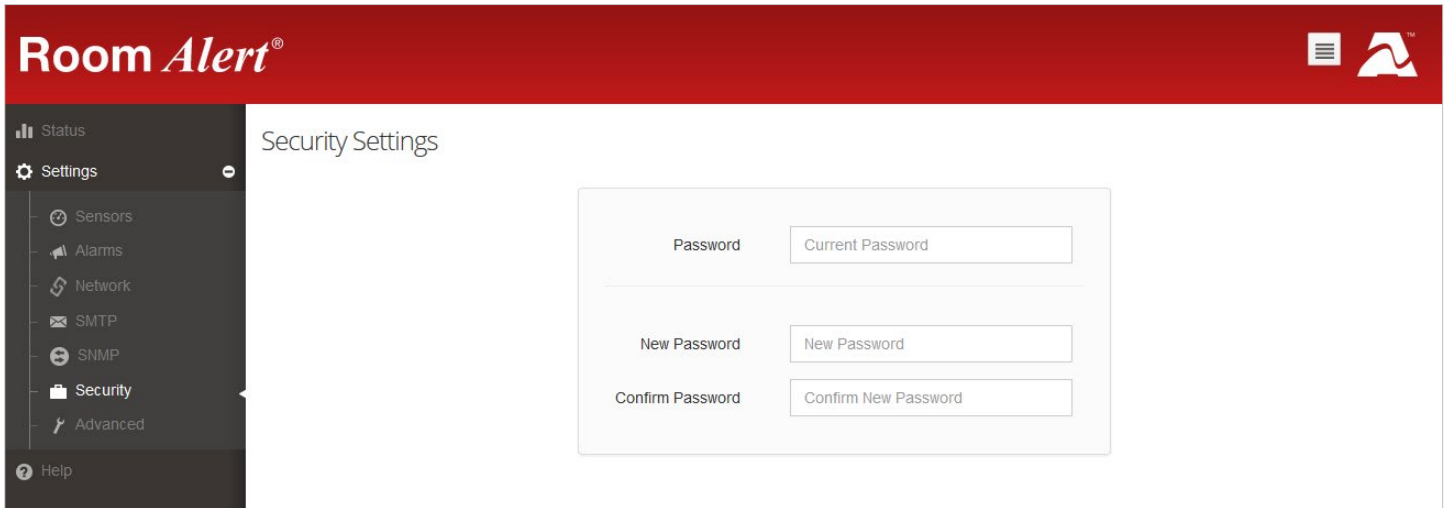

Navigate to **Settings** → **Security** to open the *Security Settings* screen.

Password

1. In *New Password*, you may create a log in password of up to 15 alphanumeric characters for your Room Alert.

TIP

Use only letters and numbers in your log in password—no special characters, please.

2. Re-enter the password in the *Confirm Password* field to verify.
3. Select **Save Settings** at the top or bottom of the page. Your Room Alert will automatically reboot and commit your changes.

NOTE

If you forget your password, you can reset your Room Alert settings to the factory defaults. Please see the [How To Reset Room Alert To Factory Defaults](#) section of this manual for more information. There is no other alternative. When you reset to defaults, you lose all of your previously configured settings, including password security.

Username (🔒 Room Alert 4E)

In addition to a password, you may, if you wish, configure a username for your Room Alert 4E.

Username	<input type="text" value="Current Username"/>
Password	<input type="text" value="Current Password"/>
New Username	<input type="text" value="New Username"/>
New Password	<input type="text" value="New Password"/>
Confirm Password	<input type="text" value="Confirm New Password"/>

1. In *New Username*, you may create a username of up to 8 characters.
2. In *New Password*, you may create a log in password of up to 15 characters.

TIP

Use only letters and numbers in your log in username and password—no special characters, please.

3. Re-enter the password in the *Confirm Password* field to verify.
4. Select **Save Settings** at the top or bottom of the page. Your Room Alert will automatically reboot and commit your changes.

NOTE

If you forget your username or password, you can reset your Room Alert settings to the factory defaults. Please see the [How To Reset Room Alert To Factory Defaults](#) section of this manual for more information. There is no other alternative. When you reset to defaults, you lose all of your previously configured settings, including username and password security.

Ping (📶 Room Alert 4E)

You may configure up to eight IP addresses to ping from your Room Alert 4E in this screen. Room Alert will send a ping to those addresses to check if the host is reachable. If the host is up, the ping will return as successful and register a normal state; if the host is down, or Room Alert cannot reach it, the ping will return as failed and register an alarm state.

Navigate to **Settings** → **Ping** to open the *Ping Settings* screen.

Room Alert®

Status

Settings

Sensors

Alarms

Network

SMTP

SNMP

Security

Ping

Advanced

Help

Ping Settings

Ping Configuration

Retry Count

Timeout

Ping Host Addresses

1	<input type="text" value="192.168.2.5"/>	2	<input type="text" value="192.168.2.10"/>
3	<input type="text" value="192.168.2.15"/>	4	<input type="text" value="192.168.2.20"/>
5	<input type="text" value="0.0.0.0"/>	6	<input type="text" value="0.0.0.0"/>
7	<input type="text" value="0.0.0.0"/>	8	<input type="text" value="0.0.0.0"/>

Ping Configuration

1. In *Retry Count*, you may enter the number connection attempts Room Alert will make before an alarm condition is generated. The default is 1.
2. In *Timeout*, you may enter the number of seconds to wait for a reply to the connection attempt.

Ping Host Addresses

3. In the *Ping Host Addresses* table, you may enter up to 8 IP addresses. The default for each is 0.0.0.0.
4. Select **Save Settings** at the top or bottom of the page. Your Room Alert will automatically reboot and commit your changes.

Advanced

You may configure a number of advanced options here, including Status screen defaults, Room Alert Manager “Push,” time & date, and trace output.

Navigate to **Settings** → **Advanced** to open the *Advanced Settings* screen. The *Advanced Settings* screen has 4 sub-tabs:

- General
- Date & Time Configuration
- Trace Configuration
- Room Alert Manager

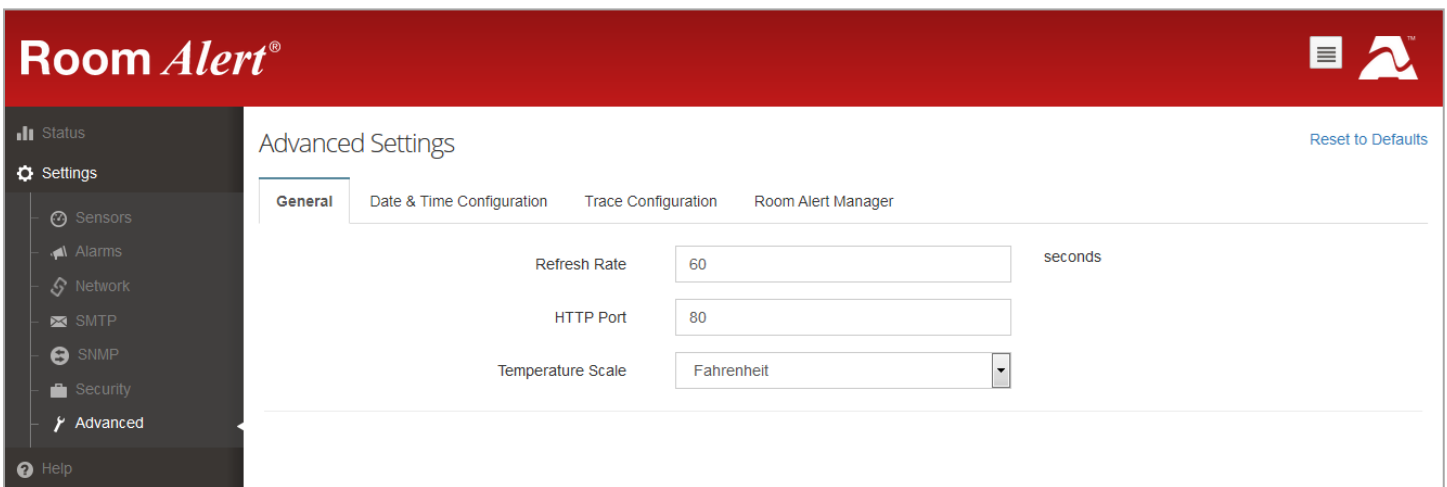

General

Navigate to **Settings** → **Advanced** → **General** to open the *General* screen, where you may set defaults for the Status screen.

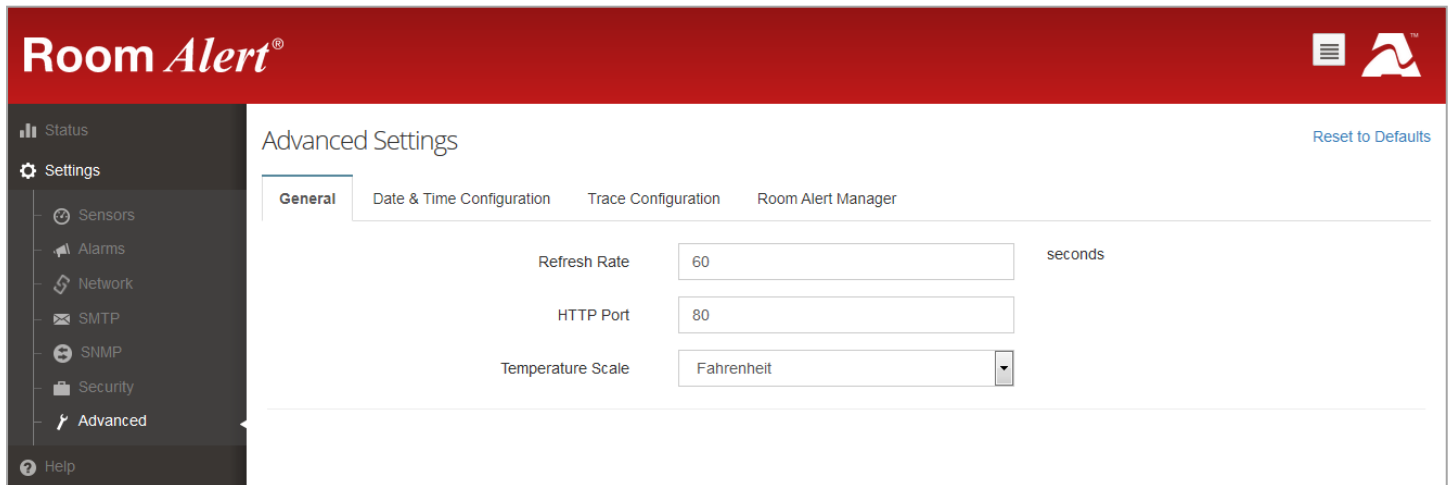

1. In *Refresh Rate* enter the number of seconds you would like the Status screen to refresh at. You may enter a value from 5 to 65535. The default is 60 seconds.
2. In *HTTP Port*, you may change the port number your web browser uses to connect to your Room Alert's web interface. It uses port 80 by default.
3. In *Temperature Scale*, you may choose **Fahrenheit** or **Celsius** from the drop-down list. **Fahrenheit** is the default.
4. Select **Save Settings** at the top or bottom of the page. Your Room Alert will automatically reboot and commit your changes.

Time & Date Configuration

Navigate to **Settings** → **Advanced** → **Date & Time Configuration** to configure the time and date defaults for your Room Alert.

The screenshot shows the 'Room Alert' interface with the 'Advanced Settings' page open. The 'Date & Time Configuration' tab is selected. The settings are as follows:

- Time Zone:** (GMT) Greenwich Mean Time (London, Lisbon)
- Time Display:** 24 hour
- Time Format:** MM/DD/YY Hour:Minute:Second
- Enable Daylight Savings:**
- Time Server:**
 - Enable custom time server: (if this is disabled time.nist.gov will be used by default)
 - IP: time.nist.gov
 - Auto Refresh: Disabled

Buttons for 'Resolve Host Name' and 'Update Now' are visible.

1. In *Time Zone*, select your time zone from the drop-down list. Greenwich Mean Time (GMT) is the default
2. In *Time Display*, you may select the 12 or 24 hour format from the drop-down list. The 24 hour setting is the default.
3. In *Time Format*, you may select either the MM/DD/YY or DD/MM/YY date format from the drop-down list. Month first (MM/DD/YY) is the default.
4. Select **Enable Daylight Savings** if you would like your Room Alert time setting to compensate by +1 hour for daylight savings time.

Time Server

5. In *IP*, you may leave Room Alert's default Network Time Protocol (NTP) server, time.nist.gov, or enter another time server IP address. To use a different IP address, you must check **Enable custom time server**, located just above this field.
6. However, if you'd rather enter your NTP hostname, select **Resolve Host Name**.

- When the *DNS Resolver* dialog box opens, enter the hostname of your time server and select **Resolve**.

Enter your NTP hostname and the device will attempt to resolve the IP address. (e.g. time.nist.gov)

time.nist.gov

Resolving time.nist.gov...

- After the resolver successfully translates the hostname into an IP address, select **Insert** to put that IP address into the *IP* field of the *Date & Time Configuration* screen.

Resolve was a success!

Resolved IP: 216.171.120.36

Click Insert to put the resolved IP into the setup form.

216.171.120.36

↓

Time Server IP [Resolve hostname?](#)

7. In *Time Server Auto Refresh*, you may select how often Room Alert automatically synchronizes with your time server.
 - You may leave the default, **24 Hours**, or choose another interval, as frequent as 10 minutes, from the drop-down list. You may also disable time synchronization by selecting **Disabled** from the drop-down list.
 - You may manually synchronize the time by selecting **Update Now**. Clicking this button does not affect the *Auto Refresh* interval.
8. Select **Save Settings** at the top or bottom of the page. Your Room Alert will automatically reboot and commit your changes.

Trace Configuration

Navigate to **Settings** → **Advanced** → **Trace Configuration** to configure your Room Alert for trace output, which is useful for troubleshooting. Trace output shows the communication between your Room Alert and your mail server, as well as other information, such as the current firmware version, IP address, MAC address, and requests to web pages.

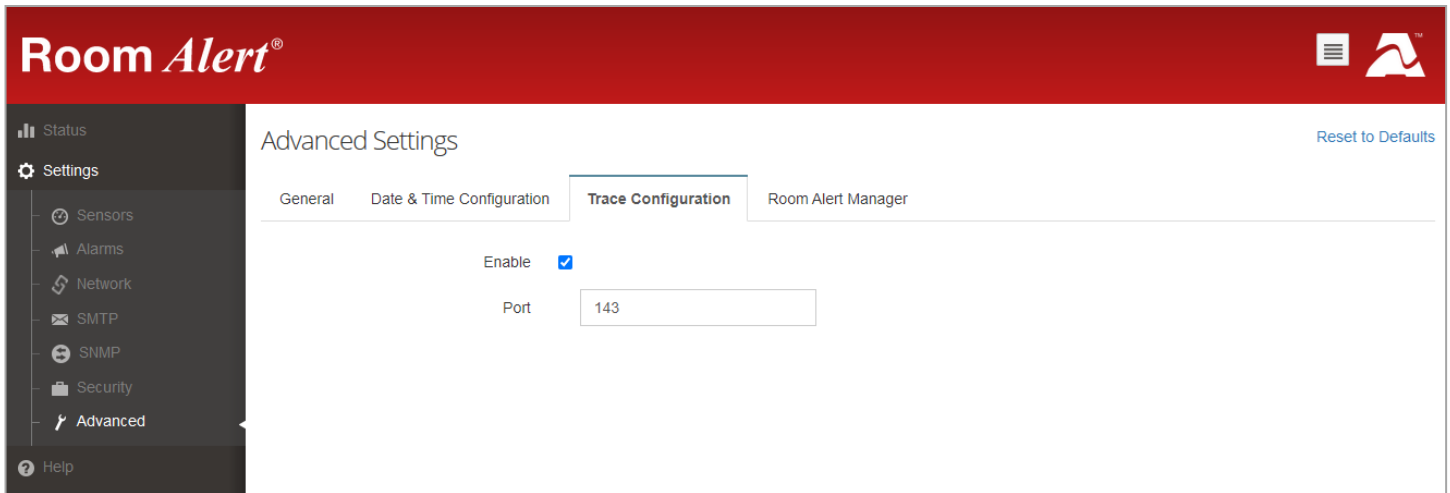

To configure trace output:

1. Select **Enable**.
2. In *Port*, you may leave the default port, 143, or enter another port number.
3. Select **Save Settings** at the top or bottom of the page. Your Room Alert will automatically reboot and commit your changes.

You may then use any standard telnet or terminal application to view the trace on the configured port.

Room Alert Manager Push Configuration

Navigate to **Settings** → **Advanced** → **Room Alert Manager** to configure settings for the unit to push to Room Alert Manager.

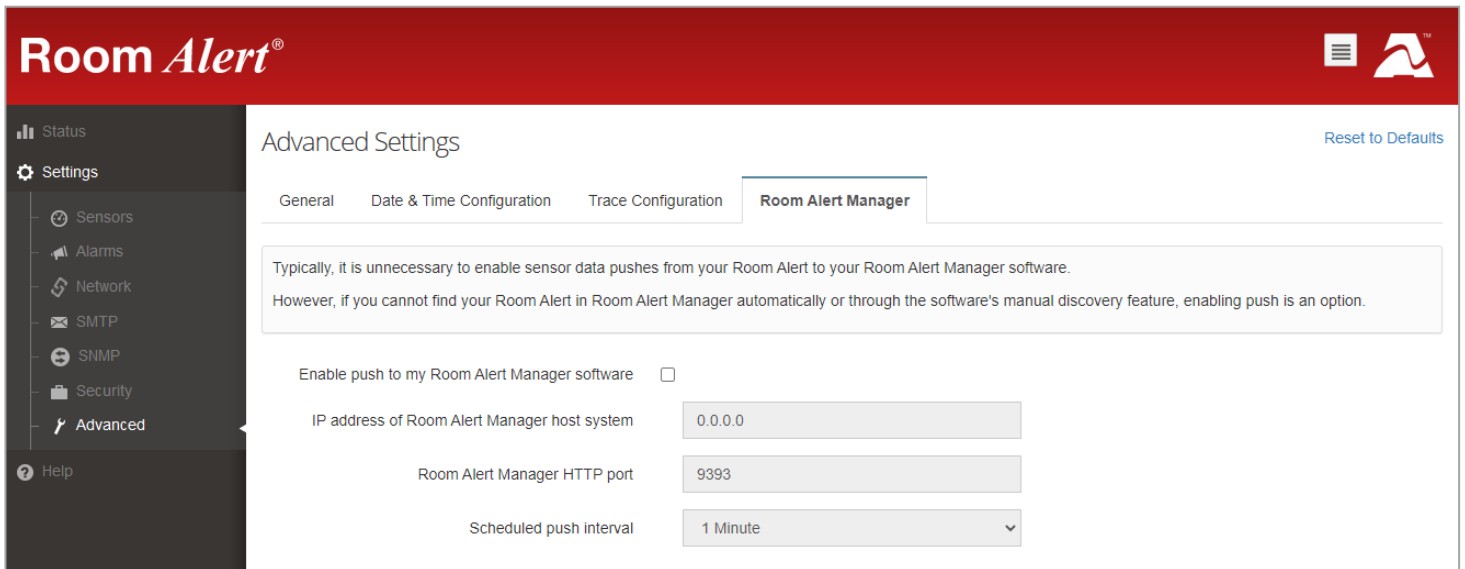

The screenshot shows the 'Room Alert' web interface. The top navigation bar is red with the 'Room Alert' logo on the left and a menu icon on the right. Below the navigation bar is a dark sidebar with a 'Settings' menu. The main content area is titled 'Advanced Settings' and has a 'Room Alert Manager' tab selected. A text box explains that enabling push is an option if the unit is not discovered automatically. Below this are three configuration fields: 'Enable push to my Room Alert Manager software' (checkbox), 'IP address of Room Alert Manager host system' (text input with '0.0.0.0'), 'Room Alert Manager HTTP port' (text input with '9393'), and 'Scheduled push interval' (dropdown menu with '1 Minute'). A 'Reset to Defaults' link is in the top right corner.

By default, Room Alert Manager queries your Room Alert for sensor values at defined intervals. However, you may configure your Room Alert to proactively send sensor updates to Room Alert Manager.

Enabling Room Alert Manager Push is an advantage for two reasons:

- Your Room Alert can communicate with Room Alert Manager from a remote network without requiring complex firewall rules on the remote network. Firewalls typically allow outgoing connections while blocking incoming connections.
- Your Room Alert can immediately send an update to Room Alert Manager when it detects an alarm, regardless of any intervals you have configured either in this section or in the Room Alert Manager discovery interval.

To enable Push to Room Alert Manager from your Room Alert:

1. Select **Enable push to my Room Alert Manager software**.
2. In *IP address of Room Alert Manager host system*, enter the IP address of Room Alert Manager's host system.
3. In *Room Alert Manager HTTP port*, enter the port Room Alert Manager uses. The default is 9393.
4. In *Scheduled push interval*, choose the number of minutes you would like between pushes when no alarms are detected.
5. Select **Save Settings** at the top or bottom of the page. Your Room Alert will automatically reboot and commit your changes.

Updating & Troubleshooting Your Room Alert

How To Download Firmware & Software Updates From RoomAlert.com

Software and firmware updates are available at your RoomAlert.com account. To download:

1. Log in to your account at RoomAlert.com.

TIP

If you've forgotten your password, select the *Forgot Password* link on the log in page and follow the on-screen instructions.

2. Select **Downloads** in the navigation bar to the left of your screen to open the *Downloads* page. There you'll see the software and firmware products you are currently enabled for. The available options are based on the registered AVTECH products for your organization.
3. To download, click the **Download** button next to the appropriate product.

How To Update Room Alert's Firmware

1. Download and save the most recent firmware update for Room Alert from your account at RoomAlert.com.
2. Open AVTECH's Room Alert Manager software or Device Discovery utility. (If you don't already have one of them installed, you may download it from your customer account.)
3. Select your Room Alert monitor from the list of discovered devices.
4. In Room Alert Manager, select the **Update Firmware** from the context menu.
Or, in Device Discovery, select the **Update** button at the top right of the screen.
5. Then follow the on-screen instructions to complete the update.

TIP

IMPORTANT: Be sure that there are no web browsers accessing your Room Alert monitor from anywhere on your network before uploading the firmware as this could cause the firmware update to be incomplete or become corrupted.

How To Discover Room Alert When Your Network Blocks UDP Broadcasts

If your network blocks UDP broadcast packets on port 30718, AVTECH's Room Alert Manager or Device Discovery might not be able to automatically locate the Room Alert monitor.

To manually discover your Room Alert, use the Advanced Discovery option:

1. Open Room Alert Manager software or Device Discovery utility. (If you don't already have one of them installed, you may download it from your account at RoomAlert.com.)
2. In Room Alert Manager, select the **Find Devices** button at the top of the Inventory list.

Or, in Device Discovery, select the **Advanced Discovery** button at the top left of the screen.

3. Enter your Room Alert monitor's IP address or the range of IP addresses assigned to DHCP devices on your network.
4. Select **Begin Scan** or **Start Scan**.
5. When the scan is complete in Room Alert Manager, select **Add Devices to Inventory** and your Room Alert should be automatically added to the list of discovered devices.

Or, once the scan is complete in Device Discovery, your Room Alert should be automatically added to the list of discovered devices.

How To Reset Room Alert To Factory Defaults

You may need to reset your Room Alert to factory defaults if:

- You are moving it to a new location and it must be reconfigured.
- It has been assigned invalid network settings and is therefore inaccessible.
- You have lost your Room Alert's password.

If your Room Alert is accessible on the network, to reset it to factory defaults:

1. Navigate to **Settings** → **Advanced** in the web interface.
2. Select **Reset to Defaults** in the upper right corner of the page.
3. Select **Yes** when the *Confirm Reset* dialog box appears.

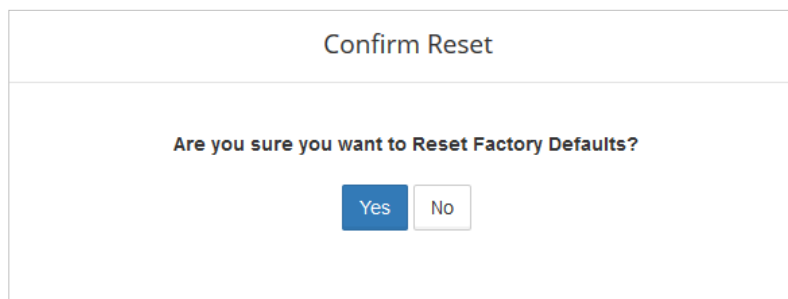

4. Your Room Alert will automatically reboot and attempt to obtain an IP address via DHCP.
5. To automatically discover your Room Alert on your network, open Room Alert Manager software, Device Discovery utility or log in to your RoomAlert.com account.

If your Room Alert is not accessible on the network, to reset it to factory defaults:

1. With your Room Alert connected to the network and powered on, press and hold the reset button for at least 10 seconds until the left LED over the network jack turns off and then on again.
2. Your Room Alert will automatically reboot and attempt to obtain an IP address via DHCP.

3. To automatically discover your Room Alert on your network, open Room Alert Manager software, Device Discovery utility or log in to your RoomAlert.com account.

TIP

IMPORTANT: When you reset to factory defaults, you lose all of your previously configured settings, including password security.